

WOODFOLD



CRAFTING VALUE FOR MORE THAN 50 YEARS

CUSTOM ACCORDION DOORS



Beyond crafting value for over 50 years, it's all about people & relationships.

Woodfold has been crafting value for more than half a century. Combine this history with today's most advanced computers and machinery and the result is an unsurpassed level of quality, efficiency and precision.



Pair that expertise with a 100% employee owned company and you have a culture filled

with extreme pride and a relentless drive to provide our customers with unsurpassed products and the shortest delivery times available in the industry. Our commitment to our customer has, and always will be, our number one focus.



Through the years we have also come to understand that for our business to endure we must

consider the relationships between the environment, our community and its people. As a responsible member of our small environmentally sensitive Oregon hamlet, sustainability is something we enthusiastically practice each and every day.



Our FSC certification* is just one more example of our commitment to

supply our customers with the most environmentally friendly door products available today.

*The FSC logo © 1996 Forest Stewardship Council A.C. FSC Chain of Custody Certification Code SCS-COC-001663.



The Woodfold manufacturing facility at Forest Grove, Oregon.

Table of Contents

- 3- The Nuts & Bolts
Packaging Promise
ADA Compatible
Recent Projects
- 4- Additional Woodfold products
- 5- Series 240
Commercial Room Dividers
- 6- Series 440 & 540
Visifold Security Doors
- 7- Series 640 & 740
Aluminum Security Doors
- 8- Series 2100
Acoustical Doors
- 9- Series 3300
Acoustical Partitions
- 10- Series 140
Residential Closet Doors
- 11- Series 220
Residential Room Dividers
and Doors
- 12 & 13- Product Specs
- 14- Panel Selections
- 15- Decorative Options
- 16- Ordering and Shipping



The Woodfold Guarantee

All Woodfold doors are custom made to fit each opening and warranted against failure due to defective materials or workmanship.

www.woodfold.com



The Nuts And Bolts Of Our Nuts And Bolts

Our exclusive steel hardware system is designed to keep doors operating smoothly and lends fantastic strength and longterm durability. It also means the doors stay solidly in place while both open and closed.



How Woodfold Door Packaging Even Protects Your Reputation

Because our accordion doors are often the final piece of a project's puzzle, the last thing you need inhibiting your project's completion is a door arriving damaged. Knowing this, we individually carton doors that are up to 15' wide. Single doors over 15' wide and Series 3300 doors are always wood crated, thus ensuring everything possible is done to have all pieces arrive undamaged.

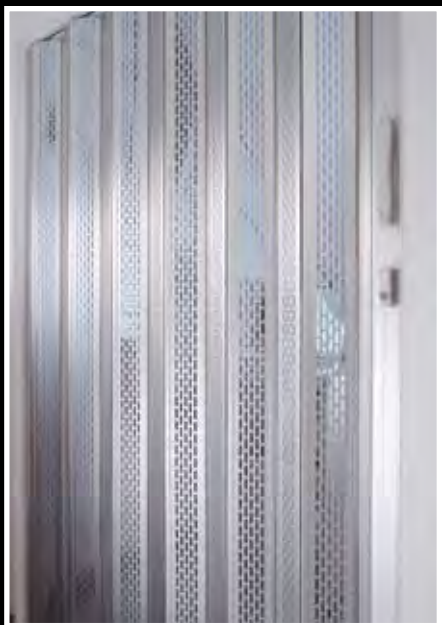

Recent Projects

You'll find Woodfold accordion doors in a great many towns across this land— probably in a lot closer proximity to your office than you thought. To find a list of our recent installations nearest you, please visit our web site.



ADA Compatible

The Series 140, 220, 240, 440, and 540 were tested for ADA compliance for opening load force per ADA/BOMA SEC 4.1311. Tests conducted by MEI Charlton, Inc., Portland, OR. Certain ADA applications may call for specific handle location placement. Consideration must be given to finished opening widths to meet ADA requirements. Please specify with order.

Proof that accordion doors and general Oregonian ingenuity are not all that comes out of our workshop.

Custom Roll-Up Doors

Crafted from select hardwoods, our roll-up doors coil conveniently overhead and are wonderfully suited for a wide variety of commercial and residential applications that call for security as well as aesthetic appeal.

Custom Wood Shutters

Enhancing interior design and the function of today's larger windows, sustainable Western Red Alder, plantation-style interior shutters are offered for commercial and residential settings in louver widths to 5-1/2".



Bookcase Doors

Our unique Bookcase Door System offers a distinctive, space-saving option for homes, lofts, efficiency units, offices, or anywhere space is limited or privacy is important. Easy to open or close it's built strong and supports a load of up to 500 pounds.

Woodfold Door Series 240

Commercial to residential. Institutional to industrial.
It's the industry leading accordion door.



No matter what space you need divided, chances are the Series 240 is the door to perfectly suit your needs. Combining the merits of durability and function with natural beauty, the Series 240 saves on floor and wall space. It also gives you choices like curvable track, locks, latches and multiple meeting posts. Simply put, the Series 240 doesn't force the choice between an elegant door and flawless functionality.

For construction details please see page 12.



Series 240 Product Specifications

Complete Product Specifications:

Please visit www.woodfold.com

Panels: 4-1/4" wide by 1/4" thick. Vinyl-Lam or hardwood veneer faces.

Panel Connectors: Flexible vinyl, color-coordinated to panel selection.

Track: 1-1/8" x 1" aluminum, dark bronze, clear or gold finish. (Curvable option available)

Wheels: Nylon wheel on steel axle with ball bearings supplied as standard.

Lead Post: 3/4" x 2-3/4" aluminum, color-coordinated to panel connector.

Jamb Molding: 1" wide by 3/8" deep aluminum.

Latch: Deadlatch with thumbturn two-sides. (Keylocks or magnetic catch options available)

Handle: Molded plastic with finger recess.

Width: No limitation.

Height: Vinyl-Lam up to 12'-1".
Hardwoods up to 10'-1".

Stacking Space: 1-1/4" per foot plus 2-3/4" for lead post.

 **ADA COMPATIBLE**
(See page 3.)

Woodfold Door Series 440 & 540

Visifold, see-through commercial security doors.

Combining the smooth, flawless operation of the Woodfold hardware hinge system with enhanced security between panels thanks to a rigid molded plastic hinge over a steel rod, the Series 540 offers an unobstructed view of what's inside while assuring protection.

The Series 440 uses the same construction, yet features a flexible vinyl panel connector in place of the knuckle hinge and steel rods. Also available with latch modifications, the Series 440 is a wonderful choice for space division where the added security of the Series 540 is not required. Additionally, the entire Visifold line can also be customized by combining acrylic panels with hardwoods, vinyl-lams or aluminum panels.



For construction details please see page 12.

Series 440 & 540 Product Specifications

Complete Product Specifications:

Please visit www.woodfold.com

Panels: Acrylic panel (transparent clear or bronze) inserted into aluminum side channels (bronze, clear, gold, sand and white) yielding 4-1/4" overall width.

Panel Connectors: Panel connectors color-coordinated to side channels.

Series 440 – Flexible vinyl.

Series 540 – Rigid vinyl with steel rods.

Track: 1-1/8" x 1" aluminum, dark bronze, clear or gold finish. (Curvable option available)

Wheels: Nylon wheel on steel axle with ball bearings supplied as standard.

Lead Post: 3/4" x 2-3/4" aluminum, color-coordinated to side channels.

Jamb Molding: Series 440 - 1" wide by 3/8" deep aluminum.
Series 540- 1-5/8" wide by 1" deep aluminum.

Latch: Series 440 - Deadlatch with thumbturn two-sides.
(Other options available)
Series 540 – Keylock two sides.
(Other options available)

Handle: Molded plastic with finger recess.

Width: No limitation.

Height: Up to 10'-1".

Stacking Space: 1-1/4" per foot plus 2-3/4" for lead post.

 **ADA COMPATIBLE**
(See page 3.)

Woodfold Door Series 640 & 740

Alumifold security doors.



A sturdy door that incorporates the smooth operation of our exclusive hardware hinge system the Series 640 and 740 feature single-piece, extruded aluminum body panels. Suitable for a variety of installations that require strength yet beauty and function, you'll appreciate design options like solid or perforated aluminum, in bronze, gold or clear (silver) finishes for a streamlined, modern look.

For construction details please see page 12.



Series 640 & 740 Product Specifications

Complete Product Specifications:

Please visit www.woodfold.com

Panels: 4-1/4" wide solid or perforated aluminum in bronze, clear or gold.

Panel Connectors: Panel connectors color-coordinated to panels.

Series 640 – Flexible vinyl.

Series 740 – Rigid vinyl with steel rods.

Track: 1-1/8" x 1" aluminum, dark bronze, clear or gold finish. (Curvable option available)

Wheels: Nylon wheel on steel axle with ball bearings supplied as standard.

Lead Posts: 3/4" x 2-3/4" aluminum, color-coordinated to panel connectors.

Jamb Molding: Series 640 – 1" wide by 3/8" deep aluminum.
Series 740 – 1-5/8" wide by 1" deep aluminum.

Latch: Series 640 – Deadlatch with thumbturn two-sides.
(Other options available)
Series 740 – Keylock two sides.
(Other options available)

Handles: Molded plastic with finger recess.

Width: No limitation.

Height: Bronze and Gold up to 8'-1".
Clear up to 10'-1".

Stacking Space: 1-1/4" per foot plus 2-3/4" for lead post.

Woodfold Door Series 2100

Single-wall doors for some degree of sound reduction.

Delivering sound reduction in an attractive, reasonably priced, single-wall door, the Series 2100 is ideal wherever some degree of sound reduction* is needed. These single-wall acoustic partitions also save floor and wall space while allowing the reconfiguration of a facility at a moment's notice.

Moreover, the Series 2100's full-perimeter seal minimizes heat loss or air exchange between rooms by adding an extruded vinyl sweep system on top and bottom, acoustically sealed track, ceiling guard and interlocking jamb molding with sound gasket.

For construction details please see page 13.



**Field Sound Transmission Class: The Series 2100 door has a field sound transmission class rating of (FSTC) 21. Field tests were performed by Bruck, Richards & Chaudiere, Inc. of Seattle, Washington following the procedures specified in ASTM designation E 336-77.*

Series 2100 Product Specifications

Complete Product Specifications:

Please visit www.woodfold.com

Panels: 4-1/4" wide by 1/4" thick. Vinyl-Lam or hardwood veneer faces.

Panel Connectors: Flexible vinyl, color-coordinated to panel selection.

Track: 2" x 1-1/8" aluminum, dark bronze or clear finish.

Sound Seal: Flexible vinyl sweep strips mounted on top and bottom of door. Wood molding mounted on both sides of track forming 4-7/8" wide sweep surface.

Wheels: Nylon wheel on steel axle with ball bearings supplied as standard.

Lead Post: 3/4" x 2-3/4" aluminum, color-coordinated to panel connectors.

Jamb Molding: 1-5/8" wide by 1" deep aluminum.

Latch: Deadlatch with thumbturn two-sides. (Keylocks or magnetic catch options available)

Handle: Molded plastic with finger recess.

Width: No limitations.

Height: Vinyl-Lam up to 12'-1".

Hardwoods up to 10'-1".

Stacking Space: 1-1/4" per foot plus 2-3/4" for lead post.

Woodfold Door Series 3300

Dual-wall doors for moderate sound reduction.

One of the most attractive ways to literally draw the line between loud and quiet, the 3300 is perimeter-sealed and acoustic-lined for wonderful sound insulation*.

Matching dual-wall construction with the proven durability of Woodfold's exclusive hardware hinge system and rigid body panels, the Series 3300 also conveniently allows the selection of alternate finish materials on each door face.

For construction details please see page 13.



**Field Sound Transmission Class: The dual-walled Series 3300 Acoustical Partition has a field sound transmission class rating of (FSTC) 33. Field tests were performed by Bruck, Richards & Chaudiere, Inc. of Seattle, Washington following the procedures specified in ASTM designation E 336-90.*

Series 3300 Product Specifications

Complete Product Specifications:

Please visit www.woodfold.com

Panels: 4-1/4" wide by 1/4" thick Vinyl-Lam or hardwood veneer faces.

Panel Connectors: Flexible vinyl, color-coordinated to panel selection.

Track: 2-7/16" x 1-3/4" aluminum, clear finish. (Heavy-duty aluminum ceiling guard with separate track available)

Sound Seal: Dual-wall door with internal sound absorbent material, flexible vinyl sweep strips mounted on top and bottom of the door. Wood molding mounted on both sides of track forming 11-5/8" wide sweep surface.

Wheels: Nylon wheel on steel axle with ball bearings supplied as standard.

Lead Posts: 2-7/8" x 4-1/2" aluminum, color-coordinated to panel connectors.

Jamb Molding: 2-1/8" wide by 15/16" deep aluminum.

Handles: Molded plastic with finger recess.

Latch: Deadlatch with thumbturn two-sides.
(Keylock option available)

Width: No limitation. (Intermediate rolling post[s] required on doors exceeding 15')

Height: Vinyl-Lam up to 12'-1".
Hardwoods up to 10'-1".

Stacking Space: 2" per foot plus 4-1/2" for lead post.

Woodfold Door Series 140

Residential closet doors.

The Series 140 is found throughout the Americas in single-family homes and is routinely specified in college dormitories, retirement homes, assisted living facilities and hospitality applications. It uses a modified version of the commercial-quality Series 240 door hardware to create a space-saving option for close-quarter applications. The Series 140 is a single door only (no pairs) and is finished on one side, providing convenient access to closets or various utility spaces. You're assured of smooth, quiet operation from our exclusive pin hinge hardware system, a sweptwing handle and integral magnet with strike plate. What's more, a variety of durable vinyl and hardwood panel options are available.

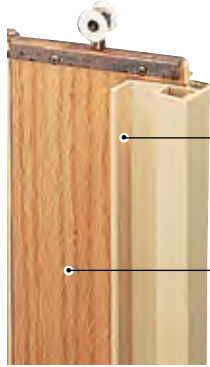

Full length sweptwing handle with integral magnet, finger-pull front side.

First panel acts as lead post. Angles to wall or jamb. (Designed as a single door unit, no pairs.)

Note: The durable Woodfold Series 140 & 220 are affordable, yet no less quality options to the Series 240, namely because they're made for residential applications that do not require the extensive features of a commercial door.

For construction details please see page 12.

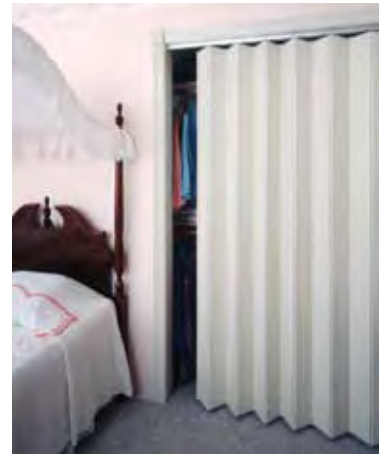

Series 140 Product Specifications

Complete Product Specifications:

Please visit www.woodfold.com

Panels: 4-1/4" wide by 1/4" thick. Vinyl-Lam or hardwood veneer faces, with utility back.

Panel Connectors: Flexible vinyl, color-coordinated to panel selection.

Track: 1-1/8" x 1" aluminum, dark bronze, clear or gold finish.

Wheels: Nylon wheel with lexan axle.

Handle: Full-length sweptwing handle attached to first panel, color-coordinated to panel connectors. Specify left or right stack.

Catch: Magnet with strike plate.

Width: Up to 8'-0".

Height: Up to 8'-1".

Stacking Space: 1-1/4" per foot plus 7/8" for sweptwing handle.



ADA COMPATIBLE
(See page 3.)

Woodfold Door Series 220

Residential room dividers and doors.

Our Series 220 is equally attractive and durable as the Series 140, but is finished on both sides. Featuring, of course, our exclusive pin hinge hardware system for smooth operation, strength and durability. The Series 220 is a wonderful option for efficiency-style housing units, basement or family room recreation areas and galley-style kitchens where the door is commonly viewed from each side. The Series 220 is a single door only (no pairs). Naturally, a variety of durable vinyl and hardwood panel options are available.

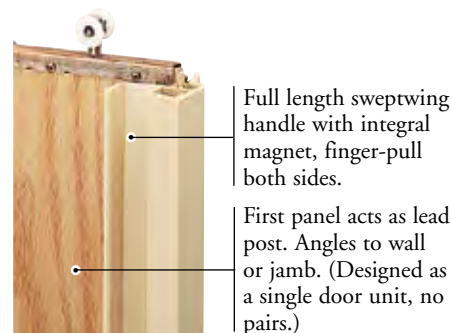
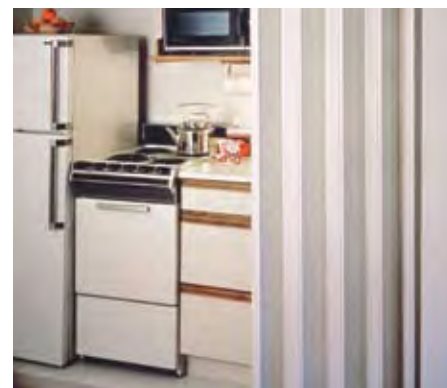

For construction details please see page 12.

Series 220 Product Specifications

Complete Product Specifications:

Please visit www.woodfold.com

Panels: 4-1/4" wide by 1/4" thick. Vinyl-Lam or hardwood veneer faces.

Panel Connectors: Flexible vinyl, color-coordinated to panel selection.

Track: 1-1/8" x 1" aluminum, dark bronze, clear or gold finish.

Wheels: Nylon wheel with lexan axle.

Handle: Full-length sweptwing handle attached to first panel, color-coordinated to panel connectors. Specify left or right stack.

Catch: Magnet with strike plate.

Width: Up to 8'-0".

Height: Up to 8'-1".

Stacking Space: 1-1/4" per foot plus 7/8" for sweptwing handle.

 **ADA COMPATIBLE**
(See page 3.)

Woodfold Door Specifications

Construction Details For Series 240, 440, 540, 640, 740

Standard Surface Track

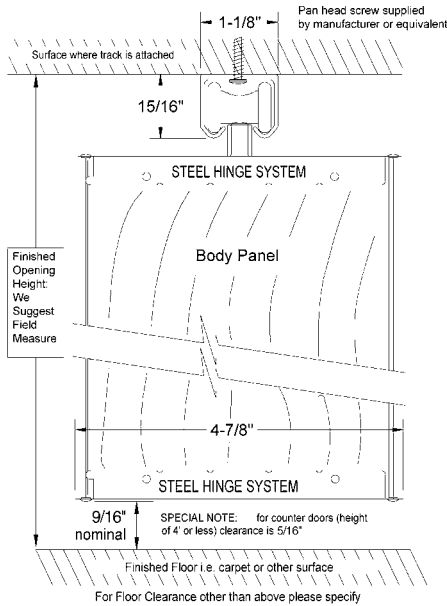

Above drawing also applies to Series 140 and 220

Stack Dimensions

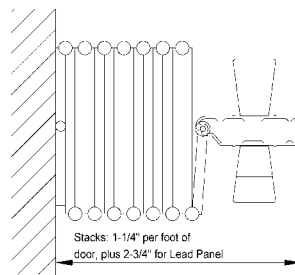

Lead Post

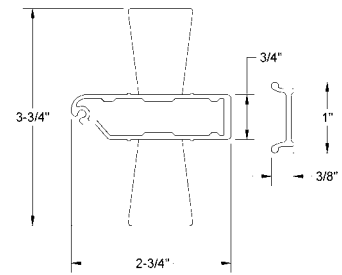

Mounting Panel

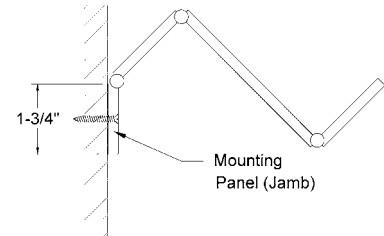

Jamb Panels may orient into or out of room based on number of panels in door.

Door Types

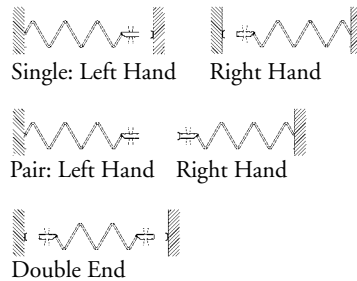

Option Details For Series 240, 440, 540, 640, 740

Recessed Track

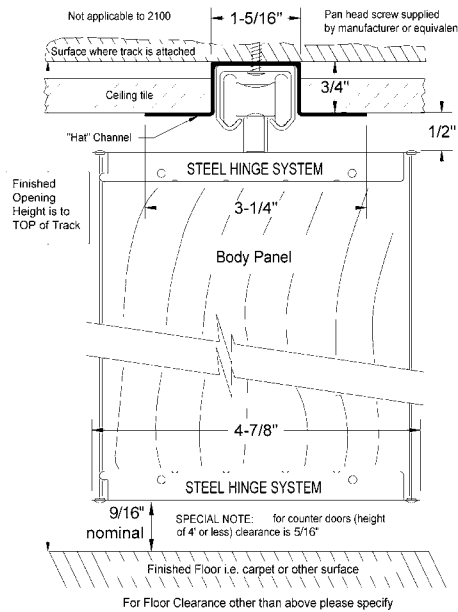

Sliding Jamb Option

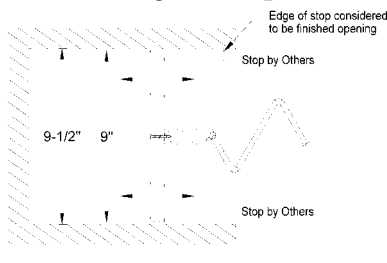

Curvable Track

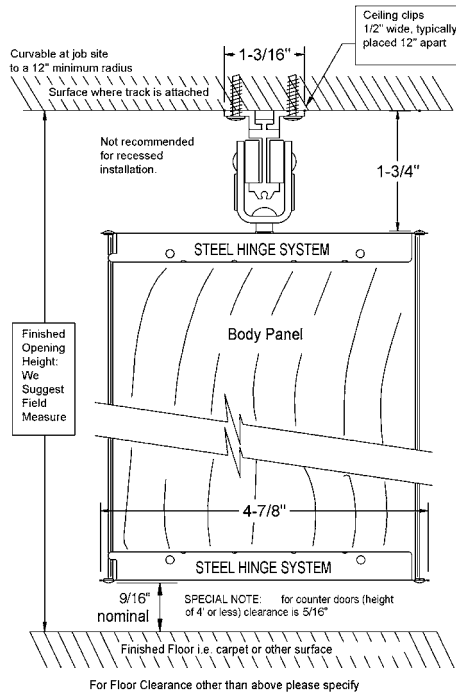

Multiple Meeting Post

See similar illustration on page 13 under Series 2100.

Locking Hardware

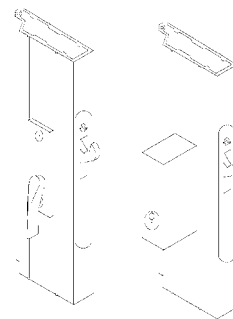

Custom Keying

Woodfold furnishes Weiser Cylinders in Adams Rite Pulls which can be adapted to Schlage, Lockwood, Sargent, Corbin, Russwin, Dexter and Medeco cylinders by your local locksmith.

Thumb Turn Pull with Cylinder

Deadlatch

Deadlatch with thumb turn two sides

Keylock One Side

Deadlatch with thumb turn one side, keylock one side

Keylock Two Sides

Deadlatch with keylock two sides

Intermediate Rolling Post

Aluminum

Each half of the post applied to section of Room Divider at plant. Fastening of sections at job site with screws and posts supplied.

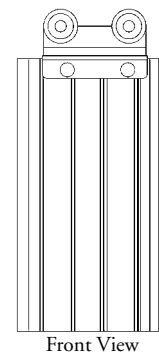

Top View without wheel assembly

Woodfold Door Specifications

Construction Details For Series 2100

Multiple Meeting Post

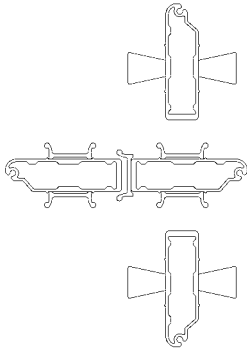

Up to four-way use of jamb mould in place of handle on sides of lead panel

Primary lead post with auxiliary jamb mouldings

Series 2100 Interlocking Jamb Molding

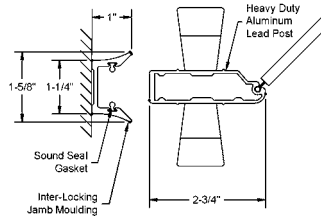

Aluminum, color-coordinated to lead post with integral sound seal gasket.

Right: Series 2100 track molding is color-coordinated solid hardwood, designed to flank the track and create a ceiling guard surface to seal top perimeters of door.

Most options shown on page 12 also apply to Series 2100.

Series 2100 Surface Track

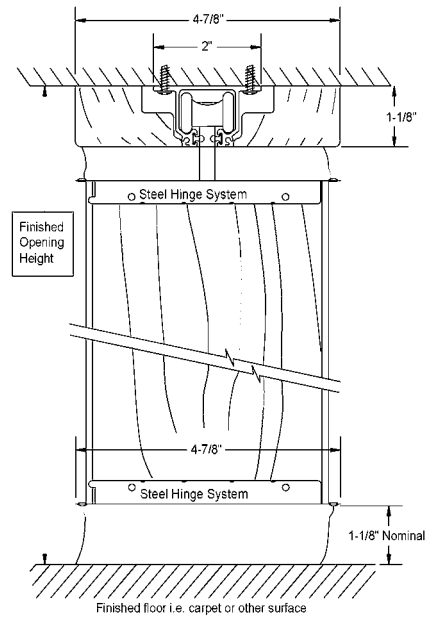

Fire-Retardant Panels

When necessary to meet requirements calling for fire-retardant panels, the following panel options are available: light oak wood grain or two-tone textured chalk laminated on both sides to a 1/4" thick material that meets Class 1 fire-retardant specifications.

Construction Details For Series 3300

Series 3300 Jamb Panel Options

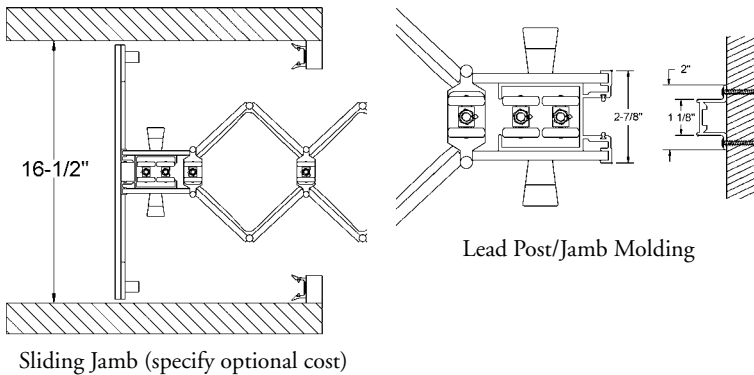

Lead Post/Jamb Molding

Sliding Jamb (specify optional cost)

Series 3300 Front View (stacked position)

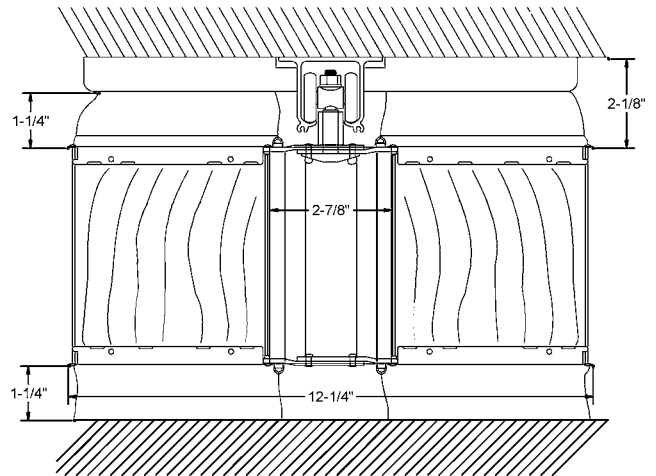

Top View/Flush Jamb Panel (specify)

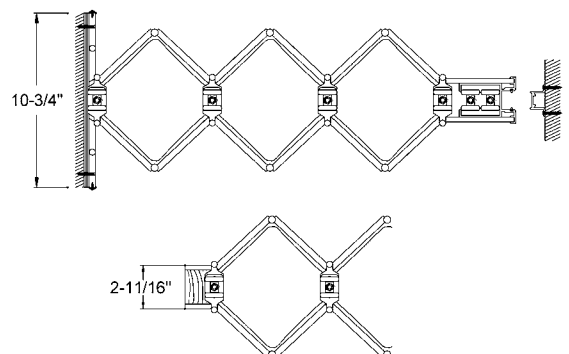

Post Jamb Panel (specify)

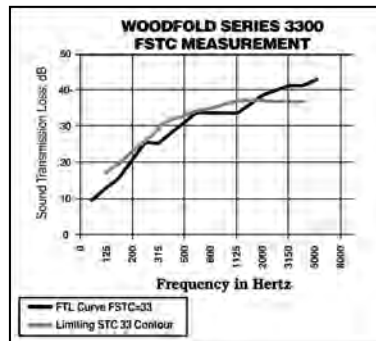

Woodgrains and Textures

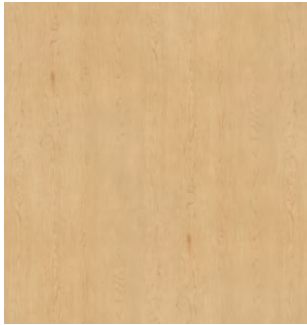

Maple



Cherry



Oak



Walnut



Driftwood



Chalk (Textured finish)

Woodfold Laminates are bonded to a 1/4" thick MDF core, minor variations may occur. Woodfold reserves the right to change selections or specifications at any time without notice. Finishes for 4100 available on separate guide Ref: WVS4100

Solids

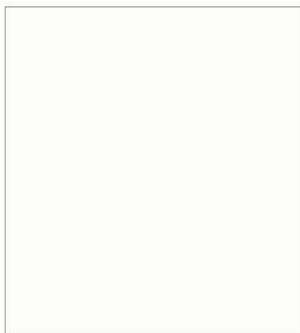

White

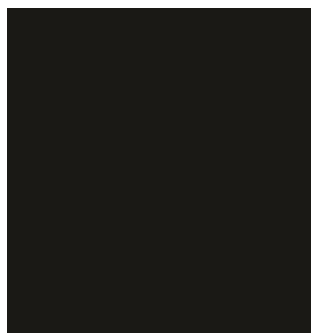

Black



Gray

WOODFOLD ACCORDION DOOR GUIDE • Detailed Architectural Shop Drawings Available.*

Code Explanations—Furnished as Standard: Std Optional: Opt N/A: Blank

Features	Series 140	Series 220	Series 240	Series 440	Series 540	Series 640	Series 740	Series 2100	Series 3300
Continuous Pin Hinge Hardware System, Top & Bottom	Std	Std	Std	Std	Std	Std	Std	Std	Std
Full-length Sweptwing Handle With Magnet	Std	Std							
Aluminum Lead Post			Std	Std	Std	Std	Std	Std	Std
Flexible Vinyl Panel Connector Inserted Directly Into Panels	Std	Std	Std					Std	Std
Flexible Vinyl Panel Connector Inserted Into Aluminum Side Channel				Std					
Flexible Vinyl Panel Connector Inserted Into Solid Aluminum Panels						Std			
Rigid Vinyl Panel Connector Inserted Into Aluminum Side Channel					Std				
Rigid Vinyl Panel Connector Inserted Into Solid Aluminum Panels							Std		
Nylon Wheel on Lexan Axle	Std	Std							
Nylon Wheel With Ball-bearings On Steel Axle			Std	Std	Std	Std	Std	Std	Std
Aluminum Track	Std	Std	Std	Std	Std	Std	Std	Std	Std
Recessed Track Channel	Opt	Opt	Opt	Opt	Opt	Opt	Opt		Opt
Curvable Track			Opt	Opt	Opt	Opt	Opt		
Magnetic Catch & Strike Plate	Std	Std	Opt	Opt	Opt	Opt	Opt	Opt	Opt
Deadlatch With Thumbturn Two-sides			Std	Std		Std		Std	Std
Keylock Two-side			Opt	Opt	Std	Opt	Std	Opt	Opt
May Be Paired			Opt	Opt	Opt	Opt	Opt	Opt	Opt
Sliding Jamb Option			Opt	Opt	Opt	Opt	Opt	Opt	Opt
Class 1 Fire Retardant Panels (Light Oak & Chalk Vinyl-Lam Only)		Opt	Opt	Opt	Opt			Opt	Opt

Special Finish Please write or email for order procedure.

Shipping Information

Schedule: All Series with factory standard finish, 2 weeks (over 250 lineal feet by quote). All doors with special finish (after signed approved acknowledgment received) 3 weeks.

Method of Shipment

Shipments to commercial addresses.

Additional charges apply for non-commercial delivery and pre-delivery notification. Contact Office for questions.

Door Weight Average

Series 140, 220, 240 440, 540, 640 740 and 2100	6-8 height	10 lbs. per lin. ft.
	8-0 height	12 lbs. per lin. ft.
	10-0 height	15 lbs. per lin. ft.
	12-0 height	18 lbs. per lin. ft.
Series 3300	8-0 height	26 lbs. per lin. ft.
	10-0 height	32 lbs. per lin. ft.
	12-0 height	38 lbs. per lin. ft.

Due to continuing product development, the information in this brochure is subject to change without notice.

All material and photographs copyrighted.

** Detailed architectural shop drawings are available at our web site.*

Architectural Specifications: Woodfold doors shall be accordion-type with panels connected continuously along the top and bottom by a steel hardware hinge system. Individual hinges are riveted to those adjoining, and contain stops to maintain a uniform extended position. Extruded vinyl seals securely connect all adjoining panels top to bottom (excluding Series 540 & 740). Doors shall be suspended by nylon wheels from aluminum overhead track. All necessary hardware and moldings shall be included for normal installation.

WOODFOLD



Woodfold Mfg., Inc.

Box 346

Forest Grove, OR 97116-0346 U.S.A.

503-357-7181 • 503-357-7185 (FAX)

Distributed By:

www.woodfold.com